

# UNIVERSAL CONTROLLER **RE62**



USER'S MANUAL



## Contents

1. APPLICATION.....	3
2. CONTROLLER SET.....	3
3. BASIC REQUIREMENTS, OPERATIONAL SAFETY.....	4
4. INSTALLATION.....	5
4.1. Mounting.....	5
4.2. External connection diagrams.....	6
4.3. Installation Recommendations.....	7
5. Starting work.....	8
6. SERVICING.....	9
6.1. Programming Controller Parameters.....	10
6.2. Controller menu.....	11
6.3. Setting Change.....	12
6.4. Parameters description.....	12
6.4.1 Individual characteristic.....	18
7. INPUTS AND OUTPUTS OF THE CONTROLLER.....	19
7.1 Measuring inputs.....	19
7.2 Outputs.....	20
8. CONTROL.....	20
8.1 ON-OFF control.....	20
8.2 SMART PID algorithm.....	21
8.2.1 Auto-tuning.....	21
8.2.2 Proceeding in case of an unsatisfactory PID control.....	23
9. ALARMS.....	23
10. ADDITIONAL FUNCTIONS.....	25
10.1 Monitoring of control signal.....	25
10.2 Manual control.....	25
10.3 Signal retransmission.....	25
10.4 Digital filter.....	25
10.6. Default settings.....	27
11. RS-485 interface (OPTIONAL).....	27
11.1 Introduction.....	27
11.2. Map of the registers.....	27
12. SOFTWARE UPDATE (OPTIONAL).....	34
13. TECHNICAL DATA.....	35
14. ORDERING CODE.....	38

## 1. APPLICATION

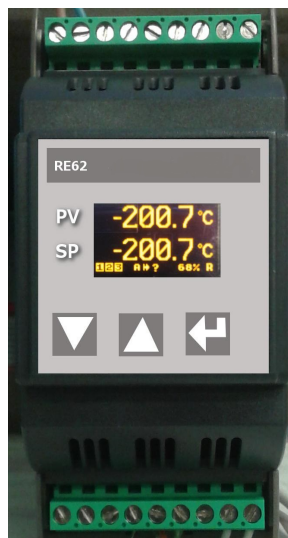
The RE62 controller is destined to control the temperature and other physical quantities (pressure, humidity, level, etc.) in plastics, food, dehydration industries and other where there is a need to stabilize the changes of the measured value. The measuring input is universal for the thermoresistors, thermocouples or standard linear signals.

The controller allows dual-point control based on the PID or ON/OFF algorithm and alert signalization. The controller can be equipped with the relay outputs, continuous output and 24 V DC power output depending on the version.

The innovative SMART PID algorithm has been implemented in the controller.

All values and the configuration parameters of the controller are available via an optional RS485 communication interface.

The output signals are galvanically isolated from the input signals and power supply.



**Figure 1. Overview of the controller**

## 2. CONTROLLER SET

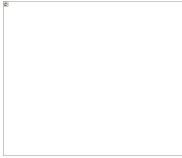
Complete set of the meter includes:

- controller 1 pc
- user's manual 1 pc

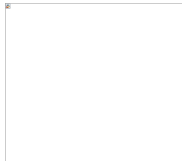
### 3. BASIC REQUIREMENTS, OPERATIONAL SAFETY

Symbols in this manual mean:

#### **Warning!**



Warning about the potentially hazardous situations. Especially important, please read before connecting the device. Non-compliance with the comments marked by this symbol could result in serious injury and damage to the device.



#### **Caution!**

Useful general notes. Please read them for easy operation. Should pay attention to them, if the device is not working as expected.

**Possible consequences in case of disregarding information!**

In terms of operational safety the controller meets the requirements of the EN 61010-1 standard.

#### **Remarks concerning safety:**

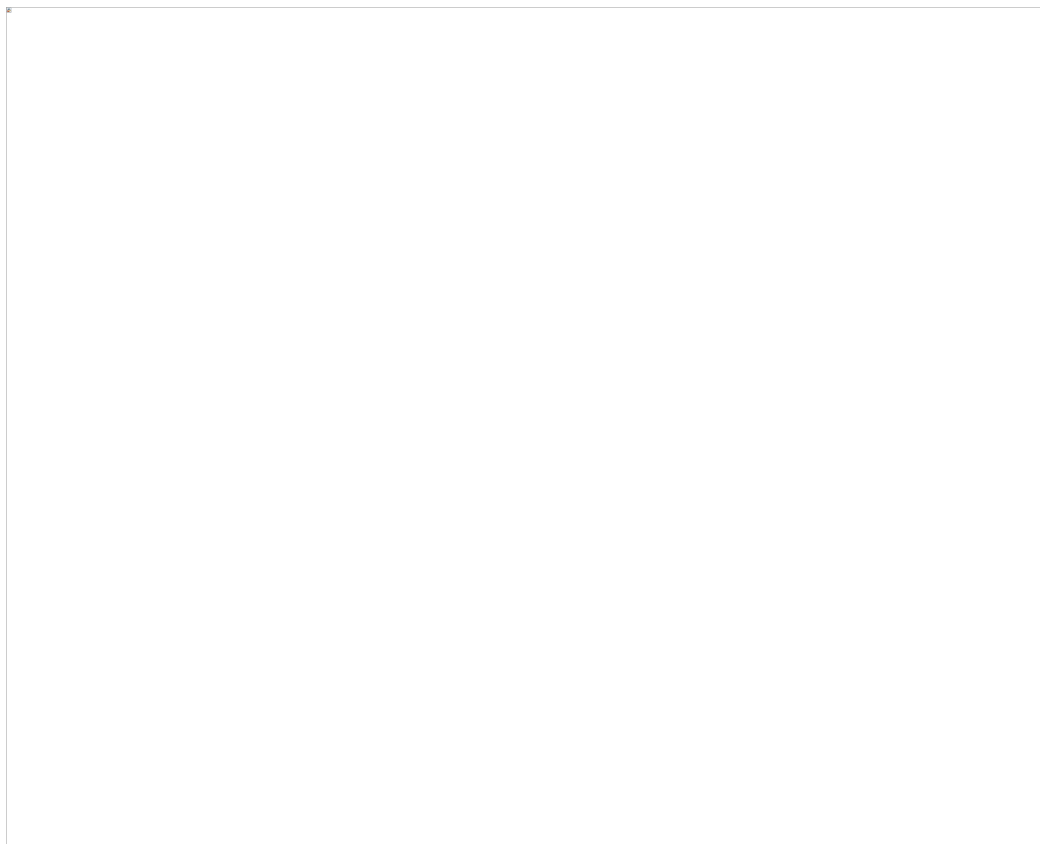


- Assembly and installation of the electrical connections should be conducted only by a person authorised to perform assembly of electric devices.
- Always check the connections before turning the meter on.
- Removal of the meter housing cover during the warranty period voids the warranty.
- The meter is designed to installation and usage in the industrial electromagnetic environment.
- A switch or a circuit-breaker should be installed in the building or facility. It should be located near the device, easily accessible by the operator, and suitably marked.

## 4. INSTALLATION

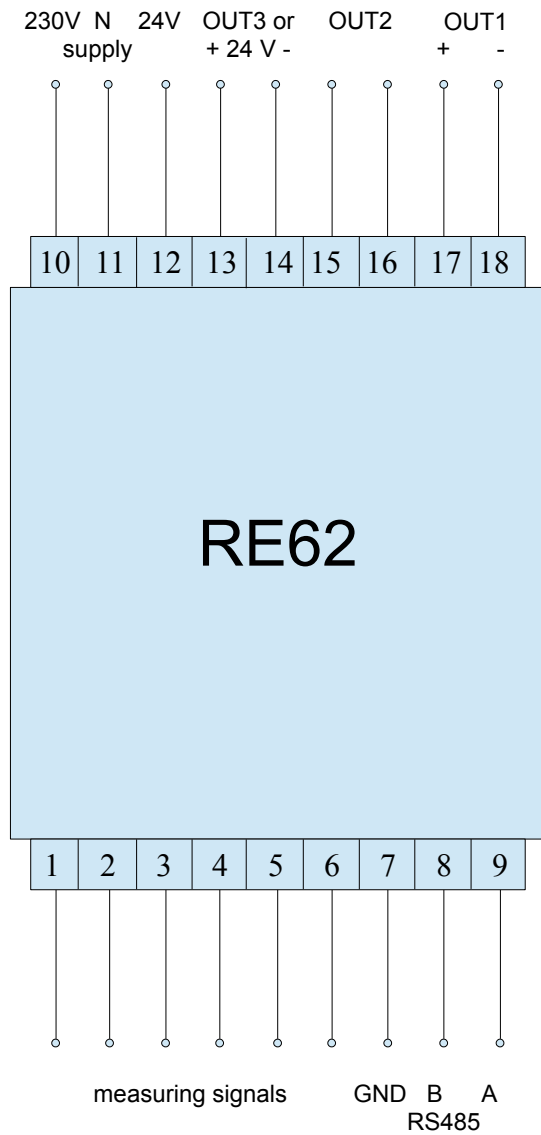
### 4.1. Mounting

The RE62 controller is designed for installation in modular distribution boards on a 35 mm rail. The controller housing is made of plastic. Housing dimensions: 53 x 110 x 60.5 mm. There are screw terminal strips on the outer side of the controller which enable the connection of external wires of diameter up to 2.5 mm<sup>2</sup>. Dimensions of the controller are presented in Fig. 2.

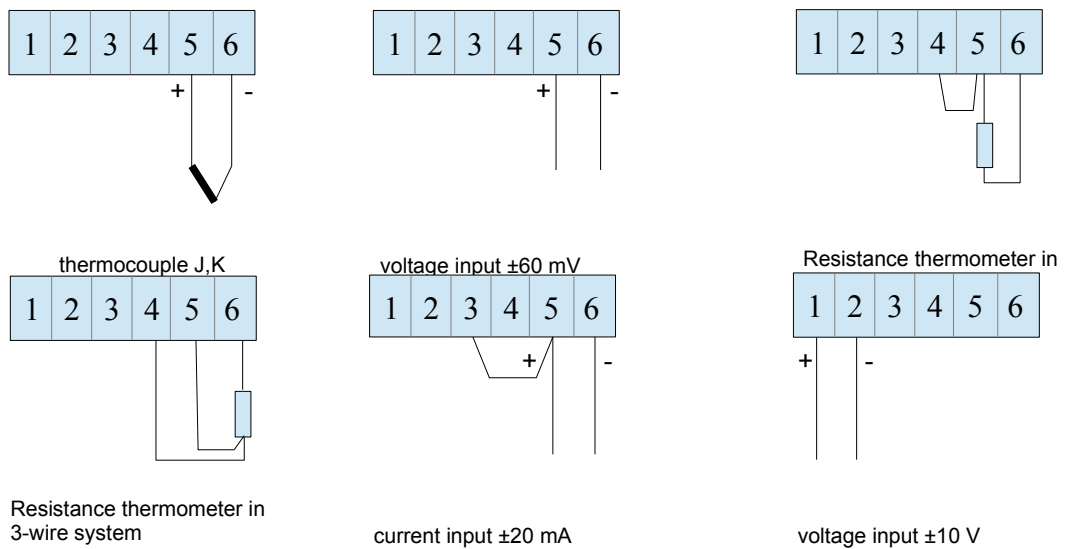


**Figure 2. Controller overall dimensions**

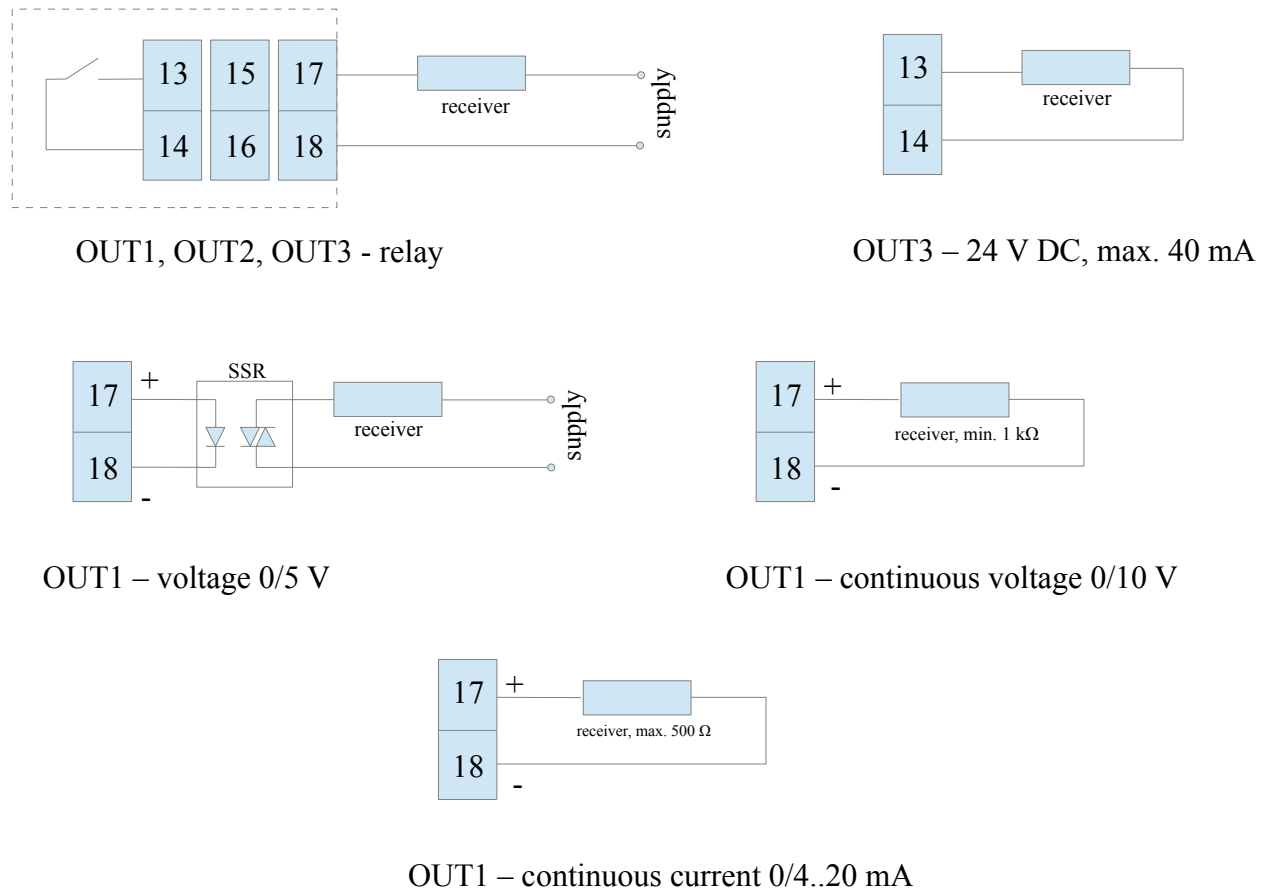
### 4.2. External connection diagrams



**Figure 3. RE62 controller electrical connections**



**Figure 4. Connections of measuring signals**



**Figure 5. Connection of the control / alarm outputs**

### 4.3. Installation Recommendations

In order to obtain full noise immunity of the controller, it is recommended to observe the following principles:

- do not supply the controller from the network, in the proximity of devices generating high pulse noise and do not apply common earthing circuits,
- apply network filters,
- wires leading measuring signal should be twisted in pairs and for the resistance sensors in the 3-wire connection they should use twisted wires of exactly the same length, diameter and resistivity protected by shielding,
- all shields should be one-side earthed or connected to the protection wire, the nearest possible to the controller,
- as a rule of thumb, wires transmitting different signals should be spaced as far as it is possible (at least 30 cm) and should be crossed only at the right angle of 90°.






## 5. STARTING WORK

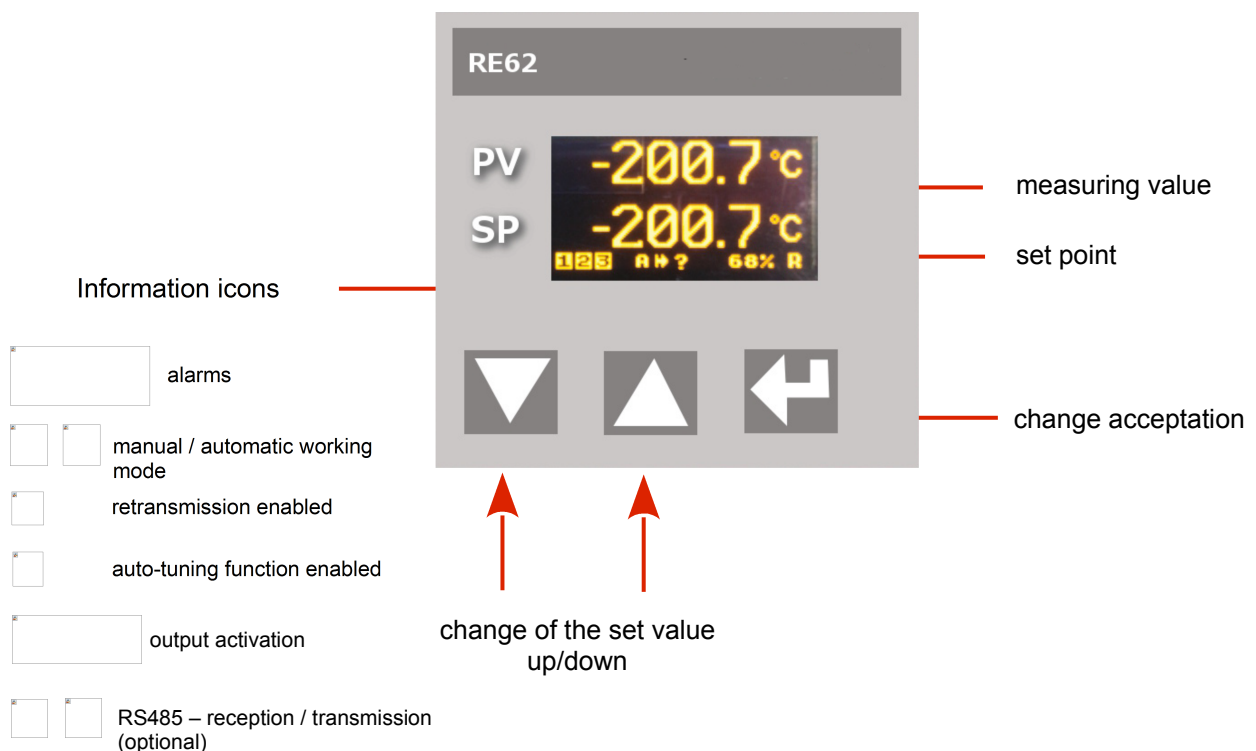
After powering on, the controller performs the display test, displays the manufacturer's logo, device type, firmware version and a controller serial number then displays a measured value and a set point.

The messages of the errors encountered in the operation of the controller may be displayed.

The PID control algorithm with a proportional band 30°C, integral time constant 300 seconds, derivative time constant 60 seconds and a pulse period 20 seconds are set by the manufacturer.

### *Change of the set point*

Change of the set point is done by pressing the button  or . New set point can be accepted by the button  during 30 seconds from last pressing of the button  or  otherwise a previous value will be restored. The parameters SPELL and SPLH set the change limitation.



**Figure 6. RE62 controller panel description**



## 6. SERVICING

The controller service is presented in Fig. 7.

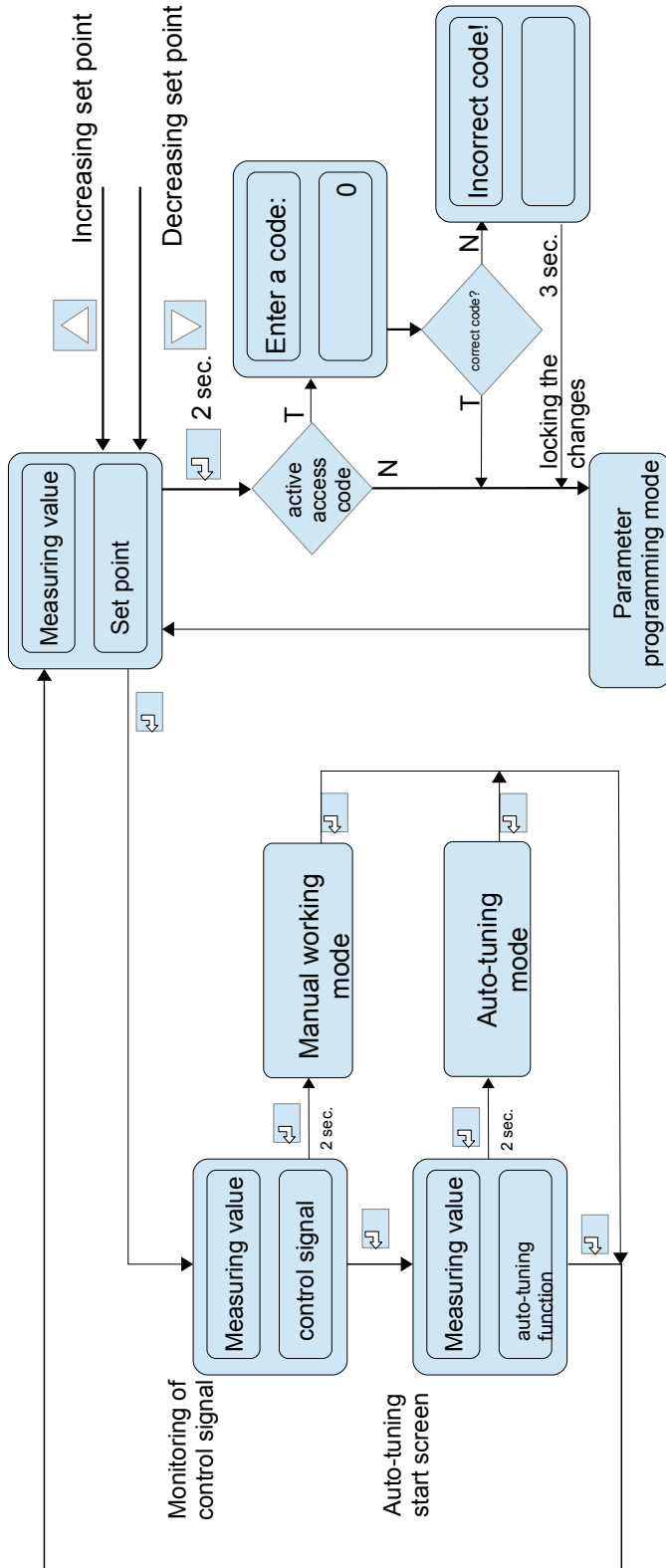


Figure 7.

Menu of controller service

## 6.1. Programming Controller Parameters











Pressing and holding down during ca 2 seconds the button  causes the entry to the controller menu. The menu can be protected by an access code. In case when giving a wrong value of the code, it is only possible to see settings through - without possibility of changes.

Figure 8 shows the menu structure in the programming mode. The transition between the levels is carried out by using the buttons  or  and the level selection by using the button . After selecting the level, the transition between parameters is carried out by using the buttons  or . In order to change the setting proceed acc. to the section 6.3. In order to exit from the selected level, transit between parameters until appears the symbol [...] and press the button . In order to exit from the programming matrix to the normal work mode, transit between levels until appears the symbol [...] and press the button . Transition to the higher level is possible by simultaneously pressing the buttons  and .







Some controller parameters can be invisible – it depends on the current configuration. The description of parameters shows the Table 1. The return to the normal work mode follows also automatically after 30 seconds since the last button pressure.

## 6.2. Controller menu

INPUT Input parameters	UNIT Measuring unit	TYPE Input type	AUTO COMPENS. Automatic compensation enabled	COMPENSATION Value of a manual compensation	DOT POINT Displayed precision	OFFSET Manually switch the measuring value by a set point	FILTER Constant value of the digital filter	USER CHAR. X1 Individual characteristic for a measuring input	USER CHAR X2 Individual characteristic for a measuring input	USER CHAR Y1 Individual characteristic for a measuring input	USER CHAR Y2 Individual characteristic for a measuring input	...	Transition to the higher level
OUTPUT Outputs parameters	FUNCTION 1 Output 1 function	TYPE 1 Output 1 type	FUNCTION 2 Output 2 function	FUNCTION 3 Output 3 function	ERROR Signal when failure	IMPULSE 1/2/3 Pulse period of output 1/2/3	...	Transition to the higher level					
REGULATION Control parameters	ALGORITHM Control algorithm	TYPE Type of control	HYSTERESIS Hysteresis	MIN. REG. Minimum control signal	MAX. REG. Maximum control signal	SELFTUNE MIN Minimum set point for auto-tuning	SELFTUNE MAX Maximum set point for auto-tuning	Transition to the higher level					
PID PID Parameters	PROPORTIONAL Proportional band	INTEGRAL Integral time constant	DIFFERENTIAL Derivative time constant	...	Transition to the higher level								
ALARMS Alarms parameters	SETPOINT 1/2/3 Set point for the alarm 1/2/3	DEVIATION 1/2/3 Deviation for the alarm 1/2/3	HYSTERESIS 1/2/3 Hysteresis of the alarm 1/2/3	MEMORY 1/2/3 Memory of the alarm 1/2/3	...	Transition to the higher level							
SETPOINT Set point parameters	VALUE Set point	UNIT Time unit of the set point ramp	STEP Ramp step in time units	LOW THRESHOLD Lower limit of the set point	UP THRESHOLD Upper limit of the set point	...	Transition to the higher level						
RETRANSMIT. Retransmission parameters	FUNCTION Retransmission function	LOW THRESHOLD Retransmission lower limit	UP THRESHOLD Retransmission upper limit	MANUAL VALUE Value set manually	...	Transition to the higher level							
RS485 Interface parameters	ADDRESS Device address in MODBUS network	BAUDRATE Baud rate	MODE Transmission mode	...	Transition to the higher level								
SERVICE Service parameters	ACCESS Access code	SELFTUNE Auto-tuning function	LANGUAGE Menu language selection	MENU TIMEOUT Exit from the menu time	RESET Restoring default settings	...	Transition to the higher level						
...	Exit from the menu												

**Figure 8. Menu of controller configuration**

### 6.3. Setting Change

The change of parameter setting begins after pressing the button  during the display of the parameter name. Buttons  and  are used for the setting choice, and the button  to accept. The change cancellation follows after the simultaneous pressure of the buttons  and  or after 30 seconds since the last button pressure.

### 6.4. Parameters description

The list of parameters in the menu is presented in the Table 1.

Controller menu

Table 1.

Parameter	Parameter description	Default setting	Range of changes
<b>INPUT – input parameters</b>			
UNIT	Displayed unit. The user-defined unit will be displayed in case of selecting the value OTHER. Defining your own units can only be performed with RS485 interface. The value OTHER is empty by default.	°C	°C °F OTHER
TYPE	Type of measuring input	PT100	±10V – input 10 V ±60mV – input 60 mV ±20mA – input 0/20 mA 4..20mA – input 4/20 mA PT100 – PT100 sensor TCJ – J type thermocouple TCK – K type thermocouple

AUTO COMPENS.	Automatic compensation enabled/disabled	ON	OFF/ ON
COMPENSATION	Value for a manual compensation	0.0	0.0..20.0 $\Omega$ – for input PT100 -20.0..60.0 $^{\circ}\text{C}$
DOT POINT	Position of decimal point	0.0	0 – without a decimal place 0.0 – 1 decimal place 0.00 – 2 decimal places
OFFSET	Shift of measuring value	0.0	-100.0...100.0
FILTER	Constant value of the digital filter	0.5 sec	0.5 sec 1.0 sec 3.0 sec 5.0 sec 10 sec 15 sec 20 sec
USER CHAR.X1	Individual characteristic for a measuring input, point X1 (Fig. 9)	0	-9999..9999
USER CHAR. X2	Individual characteristic for a measuring input, point X2 (Fig. 9)	1	-9999..9999
USER CHAR. Y1	Individual characteristic for a measuring input, point Y1 (Fig. 9)	0	-9999..9999
USER CHAR. Y2	Individual characteristic for a measuring input, point Y2 (Fig. 9)	1	-9999..9999

<b>OUTPUT – output parameters</b>			
FUNCTION 1	Output 1 function	REGULATION	<p>NONE – output disabled</p> <p>REGULATION – control signal</p> <p>ABS. UPPER – upper absolute alarm</p> <p>ABS. LOWER – lower absolute alarm</p> <p>REL. UPPER – upper relative alarm</p> <p>REL. LOWER – lower relative alarm</p> <p>INNER - internal relative alarm</p> <p>OUTER - external relative alarm</p> <p>RETRANS. - retransmission</p> <p>SENSOR ERROR - sensor failure alarm</p>
TYPE 1	Output 1 type	RELAY	<p>RELAY – relay output</p> <p>SSR – voltage output 0/5 V</p> <p>0-20 – continuous current output 0..20 mA</p> <p>4-20 – continuous current output 4..20 mA</p> <p>0-10 – continuous voltage output 0..10 V</p>

FUNCTION 2	Output 2 function	NONE	<p>NONE – output disabled</p> <p>REGULATION – control signal</p> <p>ABS. UPPER – upper absolute alarm</p> <p>ABS. LOWER – lower absolute alarm</p> <p>REL. UPPER – upper relative alarm</p> <p>REL. LOWER – lower relative alarm</p> <p>INNER - internal relative alarm</p> <p>OUTER - external relative alarm</p> <p>SENSOR ERROR - sensor failure alarm</p>
FUNCTION 3	Output 3 function	NONE	<p>NONE – output disabled</p> <p>REGULATION – control signal</p> <p>ABS. UPPER – upper absolute alarm</p> <p>ABS. LOWER – lower absolute alarm</p> <p>REL. UPPER – upper relative alarm</p> <p>REL. LOWER – lower relative alarm</p> <p>INNER - internal relative alarm</p> <p>OUTER - external relative alarm</p> <p>SENSOR ERROR - sensor failure alarm</p>
ERROR	The control signal of proportional control output in the event of a sensor failure	0.0	0.0..100.0
IMPULSE 1	Output 1 pulse period	20.0 s	0.5..99.9 s
IMPULSE2	Output 2 pulse period	20.0 s	0.5..99.9 s

IMPULSE 3	Output 3 pulse period	20.0 s	0.5..99.9 s
<b>REGULATION – control parameters</b>			
ALGORITHM	Control algorithm	PID	ON-OFF – on-off control PID – PID control algorithm
TYPE	Type of control	REVERSE D	DIRECT – direct control (cooling) REVERSED – reverse control (heating)
HYSTERESIS	Hysteresis	1.1 °C	0.2..100.0 °C
MIN. REG.	Minimum control signal	0.0 %	0.0..100.0 %
MAX. REG.	Maximum control signal	100.0 %	0.0..100.0 %
SELFTUNE MIN	Lower limit for auto-tuning	0.0 °C	MIN..MAX *
SELFTUNE MAX	Auto-tuning upper limit	800.0 °C	MIN..MAX *
<b>PID – PID parameters</b>			
PROPORTIONAL	Proportional band	30.0 °C	0.1..550.0 °C
INTEGRAL	Integral time constant	300 s	0..9999 s
DIFFERENTIAL	Derivative time constant	60.0 s	0.0..2500.0 s
<b>ALARMS – alarms parameters</b>			
SETPOINT 1	Set point for the absolute alarm 1	100.0	MIN..MAX *
DEVIATION 1	Deviation from the set point of the relative alarm 1	0.0 °C	-200.0..200.0 °C
HYSTERESIS 1	Hysteresis for the alarm 1	2.0 °C	0.2..100.0 °C
MEMORY 1	Memory of the alarm 1	OFF	OFF – off ON - on
SETPOINT 2	Set point for the absolute alarm 2	100.0	MIN..MAX *



HYSTERESIS 2	Deviation from the set point of the relative alarm 2	0.0 °C	-200.0..200.0 °C
HYSTERESIS 2	Hysteresis for the alarm 2	2.0 °C	0.2..100.0 °C
MEMORY 2	Memory of the alarm 2	OFF	OFF – off ON - on
SETPOINT 3	Set point for the absolute alarm 3	100.0	MIN..MAX *
HYSTERESIS 3	Deviation from the set point of the relative alarm 3	0.0 °C	-200.0..200.0 °C
HYSTERESIS 3	Hysteresis for the alarm 3	2.0 °C	0.2..100.0 °C
MEMORY 3	Memory of the alarm 3	OFF	OFF – off ON - on
<b>SETPOINT – set point parameters</b>			
VALUE	Set point	0.0 °C	MIN..MAX *
UNIT	Time unit of the ramp rate	°C/min	°C/min °C/h
STEP	Set point ramp rate	0.0	0..999.9 (per a time unit)
LOW THRESHOLD	Lower limitation of the fast set point change	-200.0 °C	MIN..MAX *
UP THRESHOLD	Upper limitation of the fast set point change	1372.0 °C	MIN..MAX *
<b>RETRANSMIT. – retransmission parameters</b>			
FUNCTION	Value retransmitted on the continuous output	NONE	NONE – function inactive INPUT – measuring value SETPOINT – set point HYSTERESIS – control deviation MANUAL – value set manually
LOW THRESHOLD	Lower limit of the signal to be retransmitted	0.0	MIN..MAX *

UP THRESHOLD	Upper limit of the signal to be retransmitted	100.0	MIN..MAX *
MANUAL VALUE	Manual setting of the output value	0.0	0.0..100.0
<b>RS485 – interface parameters</b>			
ADDRESS	Device address in MODBUS network	1	1..247
BAUDRATE	Baud rate	9600	4800 bit/s 9600 bit/s 19200 bit/s
MODE	Transmission mode	8n2	8n2 8e1 8o1 8n1
<b>SERVICE – service parameters</b>			
ACCESS	Access code to change controller settings	0	0..9999
SELFTUNE	Auto-tuning function	ON	OFF – locked ON - available
LANGUAGE	Menu language selection	POLISH	POLISH ENGLISH
MENU TIMEOUT	Automatic exit from the menu time	30 s	0..9999 s
RESET	Restoring default settings	OFF	OFF ON

\*) The MIN and MAX values depend on the input type. See Table 2.

Parameters depending on the measured range

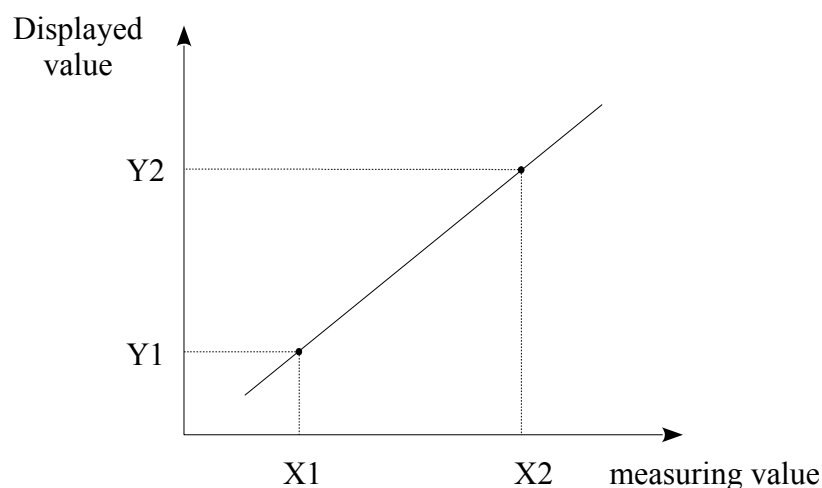
Table 2.

Input	MIN	MAX
input $\pm 10$ V	-3000.0	3000.0
input $\pm 60$ mV	-3000.0	3000.0
input $\pm 20$ mA	-3000.0	3000.0
Input 4..20 mA	-3000.0	3000.0

PT100 sensor	-100 °C	850 °C
J type thermocouple	-100 °C	1200 °C
K type thermocouple	-100 °C	1372 °C

### 6.4.1 Individual characteristic

The individual characteristic enables the conversion of the measuring value to the displayed value. It is used to visualize the measurements of non-electrical quantities using the non-electrical transducers of the standard quantities. A conversion is done by approximation with a straight line through the points which are the characteristic parameters (Figure 9).



**Figure 9. Individual characteristic**

Example: A pressure transducer with a range of 0-500 Pa and the voltage output of 0-10 V is connected to the input voltage with a range of 10 V. Set the individual characteristics as follows:

X1 – 0 (lower measuring value)

X2 – 10 (upper measuring value)

Y1 – 0 (lower output value of the pressure transducer)

Y2 – 500 (upper output value of the pressure transducer)

The meter shows the value directly in Pa after including the individual characteristic.

The individual characteristics is switched off by setting its default parameters (X1 = 0, X2 = 1, Y1 = 0, Y2 = 1)

## 7. INPUTS AND OUTPUTS OF THE CONTROLLER

### 7.1 Measuring inputs

Measuring input is the source of the measuring value used for control and alarms.

Measuring input is a universal input capable of accommodating various sensors or standard signals. Input signal is selected with a TYPE parameter in INPUT menu. Position of the decimal point that determines measuring value and set point is set through the DOT POINT parameter. The individual characteristics can be set for the linear inputs (USER CHAR.X1.Y2 parameters) to convert the value of the measuring signal to the measuring value according to the user's needs (Fig. 9). Correction of the indicated measuring value is done through the COMPENSATION parameter.

### 7.2 Outputs

The controller has a maximum of three outputs. Each of them can be set for control or alarm.

For the proportional control (with the exception of the analog outputs) a pulse period is also set. Pulse period is a time between two subsequent input engagements during proportional control. Pulse period length should be adjusted for the dynamic properties of the object and characteristics of the output device. It is recommended to use SSR transmitter for quick processes. Relay output is used for a contactor control in the slow-changing processes. Long pulse periods for quick-change processes may cause unnecessary oscillation. In theory, the shorter pulse period is, the better the control, however for the relay output a period should be as large, as possible to optimize lifespan of the relay.

Pulse period setting recommendations

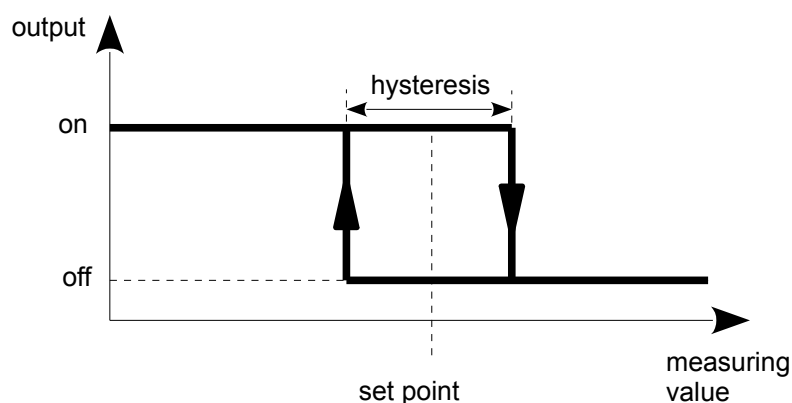
Table 3

Output	Pulse period	Load
Electromagnetic transmitter	Recommended > 20 s, min. 10 s	5 A/230 V
	Min. 5 s	1 A/230 V
Transistor output	1..3 s	semiconductor transmitter SSR

## 8. CONTROL

### 8.1 ON-OFF control

When high accuracy of a temperature control is not required, especially for the high time constant and small delay, it is possible to use ON-OFF control with hysteresis. The advantages of this method of control are simplicity and reliability. Disadvantage, however, are the oscillations even at low hysteresis values.



**Figure 10. Heating output operation**


### 8.2 SMART PID algorithm

When high precision of the temperature control is necessary, it is recommended to use PID algorithm. SMART PID algorithm used, ensures increased precision in the extended range of the control object classes.

Tuning of the controller to object is achieved by manual setting of the proportional term, derivation term or difference term or automatically – by auto-tuning function.

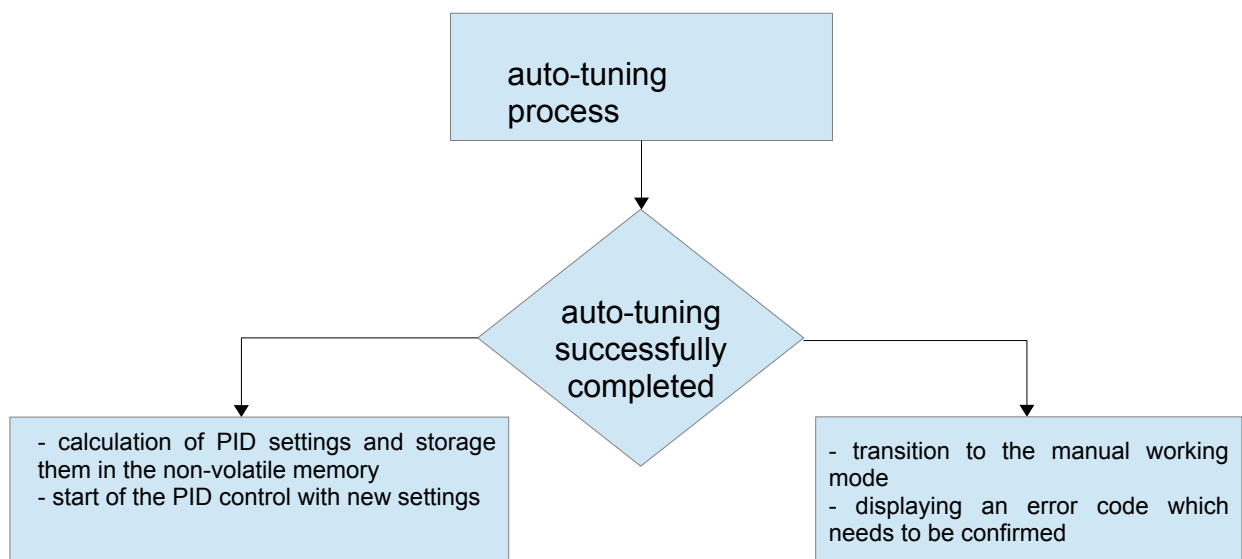
#### 8.2.1 Auto-tuning


The controller has the function to select PID settings. These settings ensure the optimal control in most cases.

To begin the auto-tuning, move to the **auto-tuning** message (acc. to the Fig. 7) and hold down the button  for at least 2 seconds. If the control algorithm is set to ON-OFF or the auto-tuning function is locked, then the **auto-tuning** message is hidden. For a correct realization of the auto-tuning function, it is required to set the parameters SELFTUNE MIN and SELFTUNE MAX. The parameter SELFTUNE MIN should be set to the value corresponding to the measuring value at the control switched off. For object temperature control, you can set 0 °C. The parameter SELFTUNE MAX should be set on the value corresponding to the maximum measuring value when the control is switched on the full power.

The duration of auto-tuning depends on dynamic object properties and can last maximally 10 hours. During auto-tuning or directly after it, over-regulations can occur and because of this set a smaller set point if possible.


The auto-tuning is composed of following stages:



The auto-tuning process will be stopped without counting PID settings, if a supply decay occurs or the button will be pressed . In this case, the control with current PID settings will be started.

If the auto-tuning does not end with success, then an error code will be displayed acc. to the Table 4.

Table 4.

<b>Error code</b>	<b>Reason</b>	<b>Proceeding</b>
ERROR 1	The set point is incorrect.	Change a set point or the parameters SELFTUNE MIN, SELFTUNE MAX.
ERROR 2	The button was pressed  .	
ERROR 3	The maximal auto-tuning duration time has been exceeded.	Check, if the sensor is correctly situated, if the set point value is not set too higher for the given object.
ERROR 4	The maximal time for switching has been exceeded.	
ERROR 5	The input measuring range has been exceeded.	Take note of the way to connect the sensor. Do not allow that the overflow results in exceeding of the input measuring range.
ERROR 6	Very non-linear object, enabling to obtain correct values of PID parameters, or an interference has occurred.	Carry out the auto-tuning again. If that does not help, choose PID parameters manually.

### 8.2.2 Proceeding in case of an unsatisfactory PID control

It is recommended to choose PID parameters, changing the value in a twice higher or twice less. During the change, one must respect following principles.

#### a) oscillations

- increase the proportional band
- increase the integral time
- decrease the derivative time

#### b) over-regulations

- increase the proportional band
- increase the integral time
- increase the derivative time

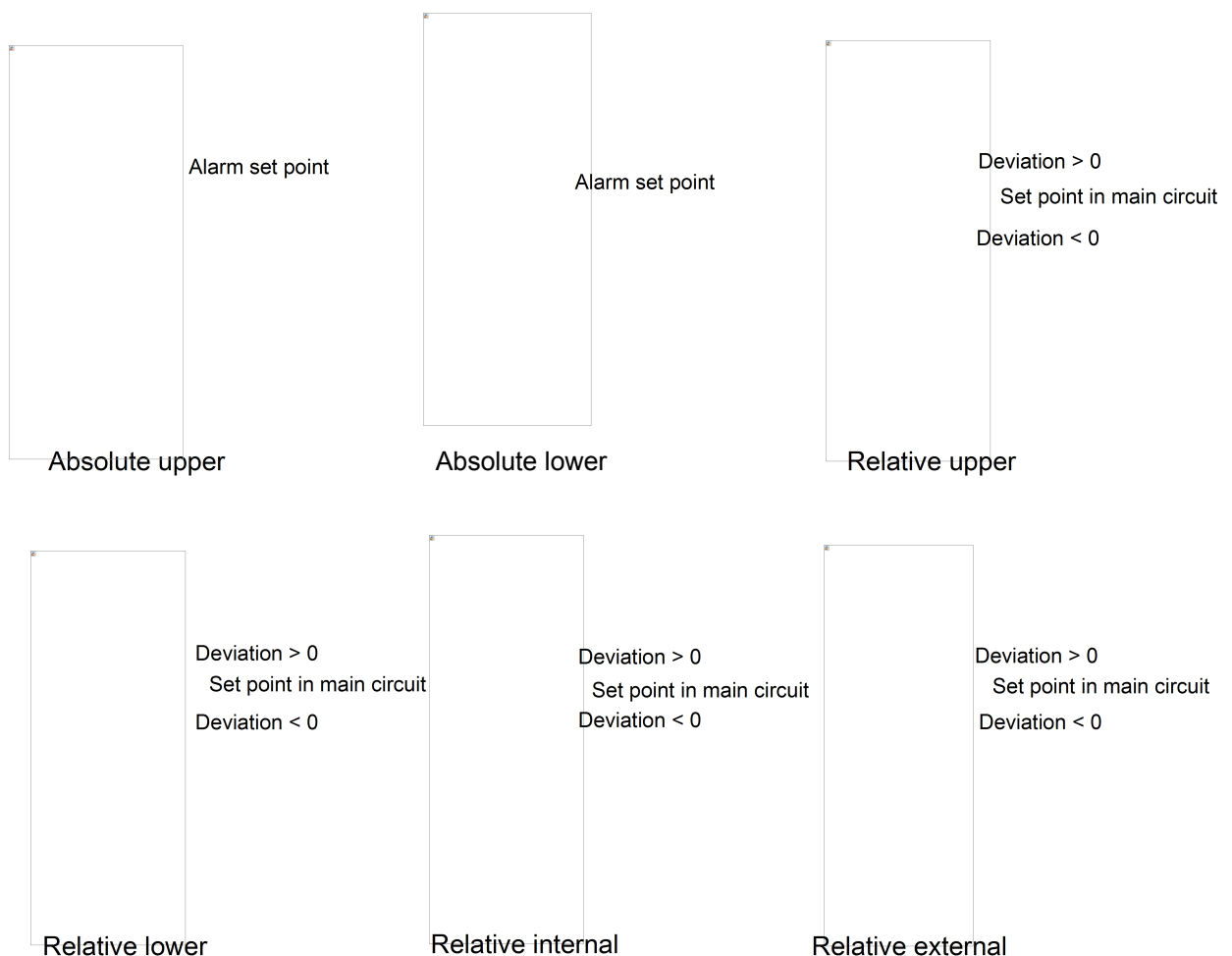
#### c) instability

- decrease the proportional band

- decrease the derivative time
- d) free jump response
  - decrease the proportional band
  - decrease the integral time

## 9. ALARMS



The controller has three alarms, which can be assigned to each output. Alarm configuration requires to select an alarm type by setting outputs parameter FUNCTION 1, FUNCTION 2, FUNCTION 3 for the appropriate alarm type. Available types of alarms are given on the Figure 10.



**Figure 11. Alarm types**




The set point for absolute alarms is the value defined by the parameter SETPOINT x, and for relative alarms, it is the deviation from the set point - the parameter HYSTERESIS x. Alarm hysteresis, the zone around the set point in which the input state is not changed is defined by the HYSTERESIS x parameter.





It is possible to set the alarm latch to save the status of the alarm after an alarm condition withdraw (the parameter MEMORY x = ON). The alarm is signaled by an alarm indicator flashing on a display. Alarm memory reset can be done by simultaneously pressing the buttons  and  in the normal work mode or via the interface.

## 10. ADDITIONAL FUNCTIONS

### 10.1 Monitoring of control signal

To display the control signal press the button  until the control signal will appear on the display as shown in Figure 7. The return to displaying set point has a default setting of 30 seconds but it can be changed or disabled by the parameter MENU TIMEOUT.

### 10.2 Manual control

The entry to the manual control mode follows after holding the button down  during the control signal display. The controller interrupts the automatic control and begins the manual control of the output. The buttons  and  are used for changing the control signal. The exit to the normal work mode follows after pressing the button  .

### 10.3 Signal retransmission

Continuous output may be used for retransmission of the selected value, e.g. for registering object temperature or copying set point in multi-zone furnaces.

Signal retransmission is possible if the output 1 is a continuous type of output. Start a retransmission configuration by setting the parameter FUNCTION 1 to RETR. Additionally, it is necessary to set

upper and lower limit of the signal to be retransmitted (LOW THRESHOLD and UP THRESHOLD). Selection of the signal to be retransmitted is done by the parameter FUNCTION in RETRANSMIT. menu. It is possible to manually set the signal on the continuous output by entering the values in MANUAL VALUE menu.

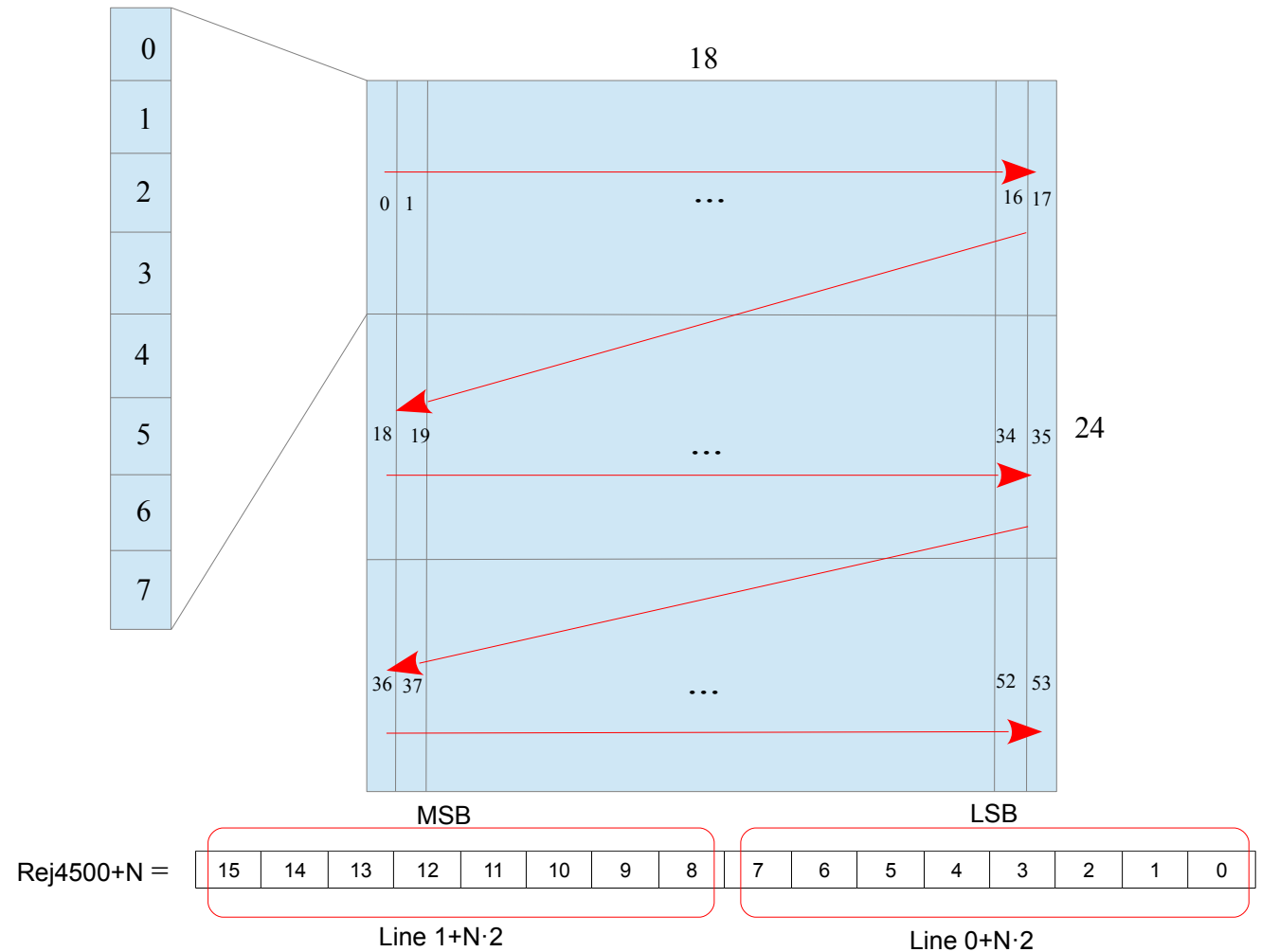
#### **10.4 Digital filter**

You can change the time constant of the digital filter if the measuring value is unstable. When using this feature, use the lowest filter time constant value that allows for the stable measuring value. When the time constant is too high, it may cause the control to become unstable. The time constant may be set from 0.5 to 20 seconds.

#### **10.5 User unit (optional)**

RE62 controller can display the unit of the measuring value defined by the user. eCon software should be used to edit and save the unit. The unit can be saved via the optional communication interface RS-485.



The image of the measuring value units uses 18x24 points of a display. This area is divided into 3 lines and each line on the 18 vertical lines with 8 points. One byte of data corresponds to each line, in which the value of 1 in a given field corresponds to turning on a given point on the display, the value 0 - turning off a given point on the display. The definition of the entire image creates a string of 54 bytes stored in 16-bit registers from the address 4500 of the controller. The 8-bit values of the lines in the 16-bit registers are arranged as shown in Figure 11.



$N = \{0...26\}$

**Figure 12. Entering the line value in the 16-bit register**

## 10.6. Default settings

Factory settings can be restored by pressing and holding the  ,  buttons within 1 second after switching the power on. Once the start logo appears, the buttons should be released. Restoring factory settings will be confirmed with an appropriate message (SET DEFAULT).

## 10.7. Detection of sensor failure

In the event of sensor failure manifesting itself in exceeding the lower or upper measuring range (shorting or opening of the measuring line), it is possible to react accordingly to the alarm output. To do this, set the SENSOR ERROR value as a function of the corresponding

controller output. When a failure occurs, the selected output will be activated and the alarm icon will be visible on the display. After the failure ceases, the selected output will be released, and the icon signaling the alarm, depending on the option of alarm memory, will be turned off or will flash until the alarm is manually reset.

## 11. RS-485 INTERFACE (OPTIONAL)

### 11.1 Introduction

RE62 controller can be equipped with RS-485 serial interface with implemented MODBUS communication protocol.

List of RE62 controller serial interface parameters:

- device address: 1..247
- baud rate: 4800, 9600, 19200 bit/s
- operating mode: RTU
- transmission mode: 8n2, 8e1, 8o1, 8n1
- data format: integer (16 bit), float (32 bit), float (2x16 bit)
- maximum response time: 500 ms
- maximum number of registers read/written in one command: 100

RE62 controller uses following protocol functions:

Table 5.

Function	Meaning
3	Readout of n-registers
6	1 register writing
16	N-registers writing
17	Slave device identification

### 11.2. Map of the registers

In the RE62 controller, data are placed in 16 and 32-bit registers. Process variables and controller parameters are placed in the address area of registers in a way depended on the variable value type. Bits in 16-bit register are numbered from the youngest to the

oldest (b0-b15). The 32-bit registers contain numbers of float type in IEEE-754 standard. Table 6 shows the registers ranges. 16-bit registers are shown in Table 7 and 10.

32-bit registers with their corresponding 2x16 bit registers are shown in Table 11. The register addresses in the tables are physical addresses.

Table 6.

Address range	Value type	Description
4000 - 4073	Integer (16 bits)	Controller configuration. Value set in the 16-bit register.
4500 - 4526	Integer (16 bits)	The user-defined graphical icon representing the unit of the measuring value.
6000 - 6018	Float (2x16 bits, byte sequence 3210)	Value is set in the two following 16-bit registers. Registers contain the same data as 32-bit registers from the area 7500. Readout registers.
7000 – 7018	Float (2x16 bits, byte sequence 1032)	Value is set in the two following 16-bit registers. Registers contain the same data as 32-bit registers from the area 7500. Readout registers.
7500 – 7509	Float (32 bits)	Value set in the 32-bit register. Readout registers.

Configuration registers of RE62 controller

Table 7.

Measuring input			
4000	RW	Selection of the measurement loop (range)	0 – voltage input $\pm 10$ V 1 – voltage input $\pm 60$ mV 2 – current input $\pm 20$ mA 3 – current input $\pm 4..20$ mA 4 – PT100 input 5 – TC J input 6 – TC K input
4001	RW	Displayed precision	0 – 0 1 – 0.0 2 – 0.00
4002	RW	Averaging time of the measurement	5, 10, 30, 50, 100, 150, 200 (x100ms)

4003	RW	Individual characteristic (X1)	-9999..9999
4004	RW	Individual characteristic (X2)	-9999..9999
4005	RW	Individual characteristic (Y1)	-9999..9999
4006	RW	Individual characteristic (Y2)	-9999..9999
4007	RW	Compensation	0..200 – for input PT100 -200..600 – for input TCJ/TCK
4008	RW	Unit	0 – Celsius 1 – Fahrenheit 2 – user defined
4009	RW	Automatic compensation	0 – off 1 – on
Outputs			
4010	RW	Output 1	0 – off 1 – control signal 2 – upper absolute alarm 3 – lower absolute alarm 4 – upper relative alarm 5 – lower relative alarm 6 – internal relative alarm 7 – external relative alarm 8 – retransmission 9 – sensor error alarm
4011	RW	Output 1 type	0 – relay 1 – voltage output 0/5 V 2 – continuous current output 4-20 mA 3 – continuous current output 0-20 mA 4 – continuous voltage output 0-10 V
4012	RW	Output 2	0 – off 1 – control signal 2 – upper absolute alarm 3 – lower absolute alarm 4 – upper relative alarm 5 – lower relative alarm 6 – internal relative alarm 7 – external relative alarm 9 – sensor error alarm
4013	RW	Reserved	

4014	RW	Output 3	0 – off 1 – control signal 2 – upper absolute alarm 3 – lower absolute alarm 4 – upper relative alarm 5 – lower relative alarm 6 – internal relative alarm 7 – external relative alarm 9 – sensor error alarm
4015	RW	Reserved	
4016	RW	The control signal of proportional control output in the event of a sensor failure	0..1000 (x 0.1 %)
4017	RW	Minimum time of output 1 engagement (pulse)	0..999 s
4018	RW	Minimum time of output 2 engagement (pulse)	0..999 s
4019	RW	Minimum time of output 3 engagement (pulse)	0..999 s
4020	RW	Shift of measuring value	-1000...1000 (x0.1)
<b>Control parameters</b>			
4021	RW	Control algorithm	0 – ON/OFF 1 - PID
4022	RW	Type of control	0 – direct control (cooling) 1 – reverse control (heating)
4023	RW	Hysteresis	2..1000 (x 0.1)
4024	RW	Minimum control signal	0..1000 (x 0.1)
4025	RW	Maximum control signal	0..1000 (x 0.1)
4026	RW	Minimum control value for auto-tuning	0..1000 (x 0.1)
4027	RW	Maximum control value for auto-tuning	0..1000 (x 0.1)
4028	RW	Reserved	
<b>PID Parameters</b>			
4029	RW	Proportional band	1..5500 (x 0.1)
4030	RW	Integral constant	0..9999
4031	RW	Derivative constant	0.0..25000 (x 0.1)
4032		Reserved	

Alarms parameters			
4033	RW	Set point of the absolute alarm 1	-30000..30000 (x 0.1)
4034	RW	Deviation from the set point of the relative alarm 1	-2000..2000 (x 0.1)
4035	RW	Hysteresis for the alarm 1	2..1000 (x 0.1)
4036	RW	Memory of the alarm 1	0 – off 1 – on
4037	RW	Set point of the absolute alarm 2	-30000..30000 (x 0.1)
4038	RW	Deviation from the set point of the relative alarm 2	-2000..2000 (x 0.1)
4039	RW	Hysteresis for the alarm 2	2..1000 (x 0.1)
4040	RW	Memory of the alarm 2	0 – off 1 – on
4041	RW	Set point of the absolute alarm 3	-30000..30000 (x 0.1)
4042	RW	Deviation from the set point of the relative alarm 3	-2000..2000 (x 0.1)
4043	RW	Hysteresis for the alarm 3	2..1000 (x 0.1)
4044	RW	Memory of the alarm 3	0 – off 1 – on
4045		Reserved	
Set point parameters			
4046	RW	Set point	-2000..13720 (x 0.1)
4047	RW	Unit of the set point ramp	0 - °C/MIN 1 - °C/h
4048	RW	Ramp step (in ramp units)	0..9999 (x 0.1)
4049	RW	Lower limitation of the set point	0..-2000 (x 0.1)
4050	RW	Upper limitation of the set point	0..13720 (x 0.1)
4051		Reserved	
Retransmission parameters			
4052	RW	Function retransmitted	0 - NONE 1 - INPUT 2 - SETPOINT 3 - DEVIATION 4 - MANUAL
4053	RW	Lower value	-2000..13720 (x 0.1)
4054	RW	Upper value	-2000..13720 (x 0.1)
4055	RW	Manual value	0..1000 (x 0.1)



4056		Reserved	
RS-485 interface parameters			
4057	RW	Device address	1..247
4058	RW	RS-485 baud rate	0 – 4800 1 – 9600 2 - 19200
4059	RW	RS-485 mode	0 – 8n2 1 – 8e1 2 – 8o1 3 – 8n1
4060	RW	Apply the changes RS-485	0 – no changes 1 – apply the settings
4061		Reserved	
Service parameters			
4062	RW	Menu locking password	0 – no password 1..9999
4063	RW	Availability of auto-tuning function	0 – none 1 - available
4064	RW	Language	0 – Polish 1 – English
4065	RW	Menu exit delay time	0..9999
4066	RW	Restore default settings	0 – no changes 1 – restore parameters
4067	R	Serial number MSB	-
4068	R	Serial number LSB	-
4069	R	Software version	-
4070	R	Status of a device	Bit mask based on Table 8
4071	R	Ordering code (configuration)	Bit mask based on Table 9
4072	R	Special build number (KWS)	0 – standard version
4073	RW	Save parameters in non-volatile memory	0 – don't save 1 – save

## RE62 controller status

Table 8.

0	Alarm 1 status: 0 – no alarm, 1 – alarm active	3	KL1 button status: 0 – released, 1 - pressed
1	Alarm 2 status: 0 – no alarm, 1 – alarm active	4	KL2 button status: 0 – released, 1 - pressed
2	Alarm 3 status: 0 – no alarm, 1 – alarm active	5	KL2 button status: 0 – released, 1 - pressed

6	Reserved	11	Upper limit overrun in a measuring loop
7	Retransmission enabled	12	Lower limit overrun in a measuring loop
8	Control: 0 – automatic, 1 - manual	13	Reserved
9	Auto-tuning enabled	14	Calibration error
10	Auto-tuning unsuccessfully completed	15	Controller memory checksum error

## RE62 controller configuration

Table 9.

0..2	OUT1: 0 – none, 1 – relay, 2 – 0..10 V, 3 – 0..20 mA, 4 – 0/5 V	5	RS-485: 0 – none, 1 - present
3	OUT2: 0 – none, 1 - relay	6..15	Reserved
4	OUT3: 0 – 24 V DC or none, 1 – relay		

## User unit registers of RE62 controller

Table 10.

User unit		
4500	RW	Image bit data of a graphic symbol of the measuring value unit as shown in Figure 11. Lines 1, 0.
4501	RW	Lines 3, 2
...	RW	
...	RW	
...	RW	
4526	RW	Lines 53, 52

## Measurement registers of RE62 controller

Table 11.

Measurements			
6000/7000	7500	R	Displayed value
6002/7002	7501	R	Measuring value
6004/7004	7502	R	Thermocouple terminal temperature
6006/7006	7503	R	Thermocouple terminal temperature with correction
6008/7008	7504	R	Value from AC converter
6010/7010	7505	R	Value from AC converter averaged
6012/7012	7506	R	Control signal
6014/7014	7507	R	Current set point
6016/7016	7508	R	Reserved
6018/7018	7509	R	Reserved

## 12. SOFTWARE UPDATE (OPTIONAL)

A feature implemented in the RE62 controller enables to upgrade firmware using a PC with e-Con software installed. Update can be done via controller's optional communication interface RS-485. A PC requires for communication a RS-485 converter connected to USB port, for example PD10 converter.

### 13. TECHNICAL DATA

#### Measuring ranges:

Voltage measurement range Un:

-72 mV ... -60 mV ... 60 mV ... 72 mV    input resistance > 1 M $\Omega$   
-12 V ... -10 V ... 10 V ... 12 V        input resistance > 1 M $\Omega$

Current measurement range In:

-24 mA ... -20 mA ... 20 mA ... 24 mA    input resistance < 50  $\Omega$   $\pm$  1%

Temperature measurement - Pt100:

-100 °C...850 °C                            sensor current < 300  $\mu$ A

Temperature measurement - J thermocouple:

-100 °C...1200 °C

Temperature measurement - K thermocouple:

-100 °C...1370 °C

Preheating time:

30 minutes

Intrinsic error:

$\pm$  (0.2% of a range + 1 digit)

Additional errors in rated operating conditions:

- compensation of reference junction temperature changes  
 $\pm$  0.2% of the range
- compensation of resistance of wires changes  
 $\pm$  0.2% of the range
- from ambient temperature changes  
 $\pm$  (0.1% of the range /10 K)

Averaging time:         $\geq$  0.5 s (default)

External transducers supply output (OUT3)\*: 24 V  $\pm$  15% 40 mA

Relay output (OUT1, OUT2, OUT3):

NO contacts

load 250 V~/5 A~

switching number  $1 \times 10^5$

Analog output (OUT1)*:	current 0/4..20 mA $\pm$ 0.2% ( $R_o \leq 250 \Omega$ ) voltage 0..10 V $\pm$ 0.2% voltage 0/5 V
Serial interfaces*:	RS-485, address 1..247; 8N2, 8E1, 8O1, 8N1 modes; baud rate 4.8, 9.6, 19.2 kbit/s,  Broadcast address: 253 transmission protocol: modbus RTU response time: 100 ms
Protection grade:	
	from the front IP 30
	from terminals side IP 20
Power consumption in supply circuit:	$\leq 5$ VA
Weight	< 0.2 kg
Overall dimensions	53 x 110 x 60.5 mm

### Rated operating conditions.

- supply voltage 22..60 V AC 50..400 Hz / 20..60 V DC  
(terminals 11-12)
- 60..253 V AC 40..400 Hz / 60..300 V DC  
(terminals 10-11)
- ambient temperature -10 .. 23.. +55 °C
- storage temperature - 25 .. +75 °C
- humidity < 95% (condensation of water vapor  
not permissible)
- external magnetic field 0..40 ..400 A/m
- long-term overload: voltage, current measurement 20 %
- short-term overload (1 s)
- sensors inputs 10 V

voltage inputs	2 Un
current inputs	10 In
- working position	vertical
- warm-up time	15 min.
-	

**Readout field:** OLED display 128x64 points, amber

**Electromagnetic compatibility:**

- noise immunity acc. to EN 61000-6-2
- noise emission acc. to EN 61000-6-4

**Safety requirements:**

according to EN 61010-1 standard

- isolation between circuits: basic
- installation category III,
- pollution grade 2,
- maximum phase-to-earth operating voltage:
  - for supply circuit 300 V
  - for measuring input 50 V
  - for remaining circuits 50 V
- altitude a.s.l. < 2,000 m

\*) presence of the output depends on the regulator version

## 14. ORDERING CODE

RE62 controller comes as standard with:

- universal inputs
- 1 relay output OUT2
- supply voltage 22 V AC/DC, 230 V AC/DC

Order code of RE62 controller

Table 9.

Order code:	XXXX	X	X	X	XX	X	X
Controller	<b>RE62</b>						
<b>Additional output OUT1</b>							
None		<b>0</b>					
Relay 5A 230 V		<b>1</b>					
0/4...20mA (galvanically isolated)		<b>2</b>					
0...10 V (galvanically separated)		<b>3</b>					
0/5 V 30 mA (for SSR, galvanically isolated)		<b>4</b>					
<b>Additional output OUT3</b>							
None			<b>0</b>				
Relay 5A 230 V			<b>1</b>				
Power output 24 V DC/40 mA (galvanically isolated)			<b>2</b>				
<b>Communication interface RS-485</b>							
None				<b>0</b>			
RS-485 (galvanically isolated)				<b>1</b>			
<b>Version</b>							
Standard					<b>00</b>		
Custom-made*					<b>XX</b>		
<b>Language</b>							
Standard, Polish						<b>P</b>	
Standard, English						<b>E</b>	
Other*						<b>X</b>	
<b>Acceptance tests</b>							
Without extra requirements							<b>0</b>
With quality inspection certificate							<b>1</b>
With calibration certificate							<b>2</b>
Acc. to customer's request*							<b>X</b>

\*) after agreeing with the manufacturer

**ORDERING CODE EXAMPLE:**

The code RE62 20100E0 means:

RE62 – RE62 controller

2 – with continuous output 0/4..20 mA

0 – without OUT3 output

1 – with interface RS-485

00 – standard version

E – English language

0 - without extra requirements.



**LUMEL S.A.**

ul. Sulechowska1, 65-022 Zielona Góra, POLAND

tel.: +48 68 45 75 100, fax +48 68 45 75 508

[www.lumel.com.pl](http://www.lumel.com.pl)

**Export department:**

tel.: (+48 68) 45 75 139, 45 75 233, 45 75 321, 45 75 386

fax.: (+48 68) 32 54 091

e-mail: [export@lumel.com.pl](mailto:export@lumel.com.pl)